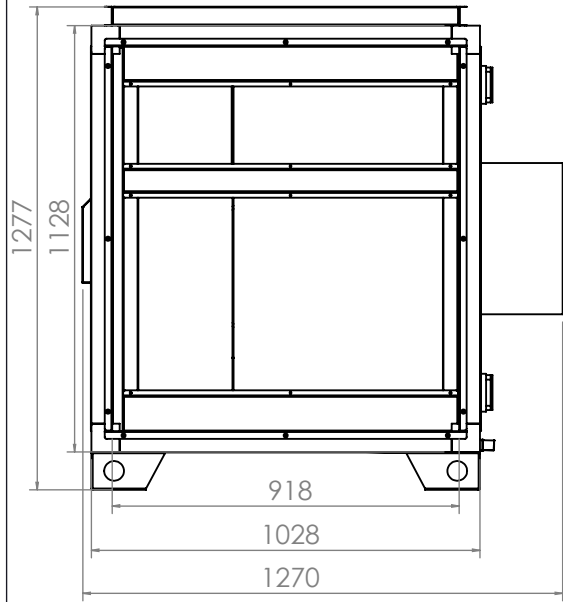
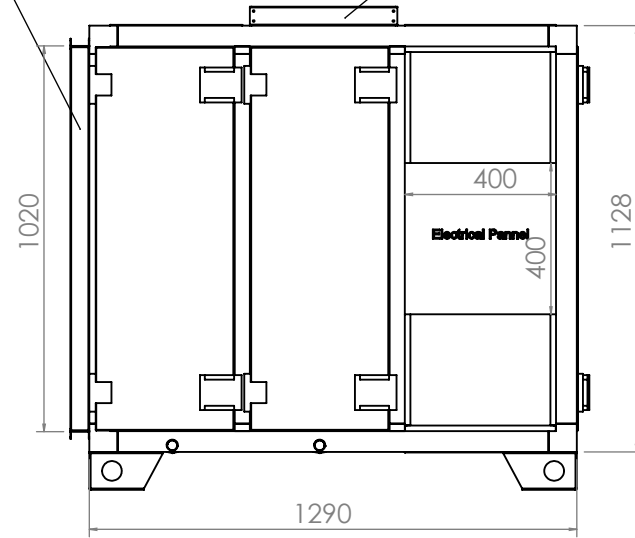

Yan/Side

Dönüş  
Return

Ön/Front

Egzoz  
Exhaust

Yan/Side

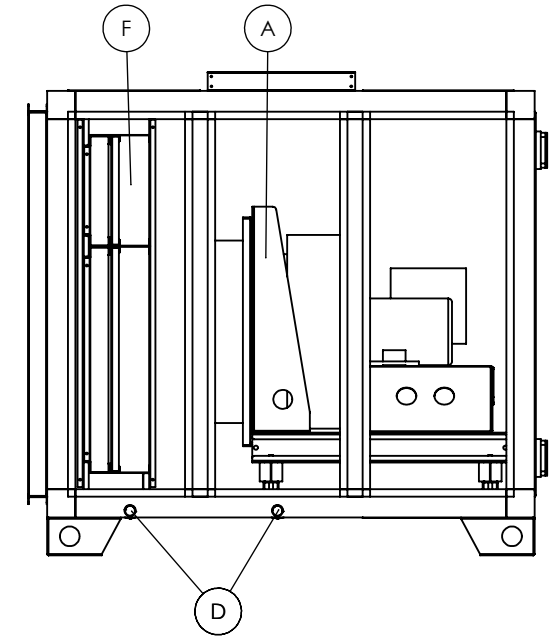
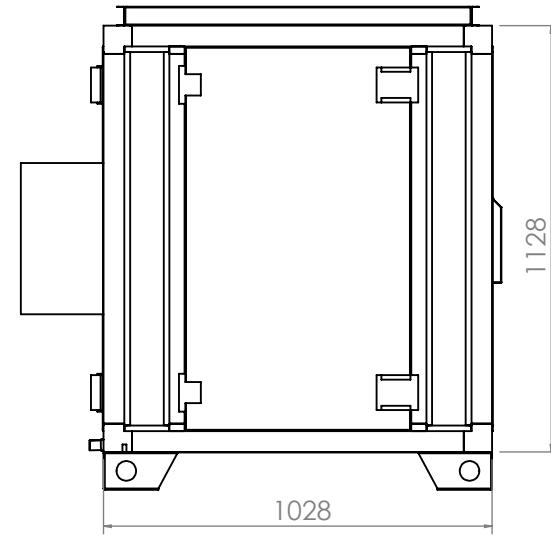

Perspektif/Perspective

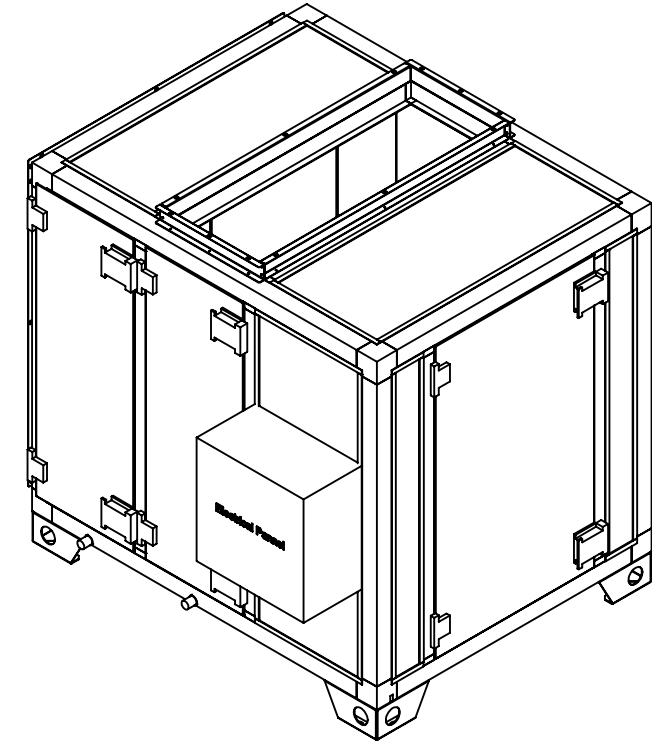

Arka/Back

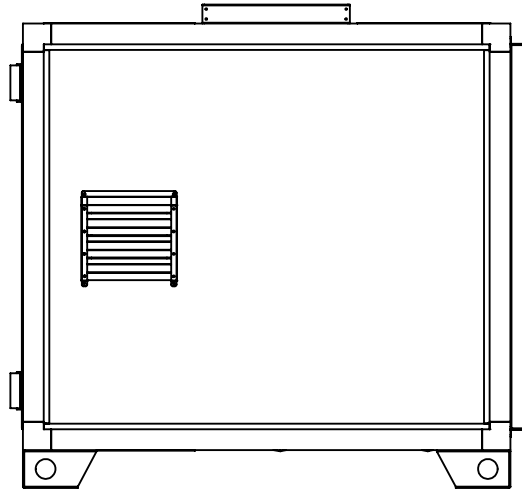

Taban-Base Plan

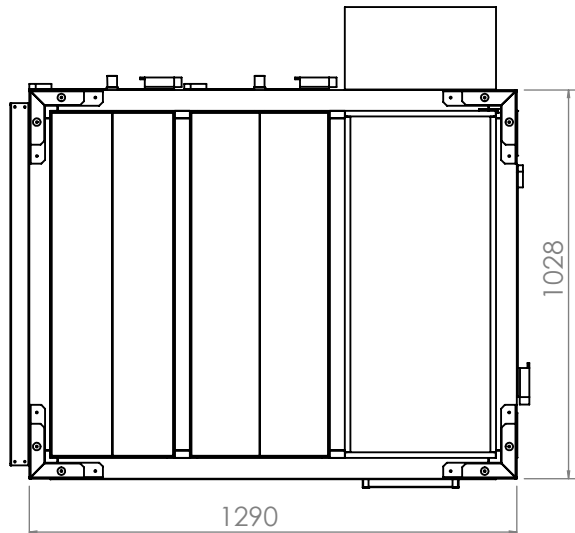

Symbol	Defination
C	Hücre birleştirme/Section con.
T	Taşıma yeri/Lifting area
F	Filtre/Filter
D	Drenaj/Drainage
DA	Alüminyum damper/Aluminum
BD	Back draft damper
V	Vantilator
A	Aspirator
P	Plakalı lgk/Plate heat exc.
R	Rotorlu lgk/Rotary heat exc.
S	Susturucu/Silencer
CC	Soğutma bataryası/Cooling coil
HC	Isıtma bataryası/Heating coil
DX	Direkt genişmeli/Direct exp.
DE	Damla tutucu/Drop eliminator
FG	Fan koruma sacı/Door guard
FC	Frost Coil
DPT	Fark basınç trans/Dif. pres.trans.
DPS	Fark basınç anah./Dif. pres switch
MS	Bakım anahtarı/Maintan. switch
ES	Acil durdurma/Emerg. stop
PT	Sıcaklık sens./Temper. sens.
E	Elektrik bağ./Electrical con.
EH	Elektrikli ısıtıcı/Electrical heater
EP	Elektrik pano/Electrical board
FT	Donma termostati/Freezing
LS	Aydınlatma anahtarı/Lighting switch
EB	Esnek Bağlantı/Flexible Connection

PROJE ADI	SEMBOL CONSTRUCTION - AKMR FAN		13231 B52	
PROJE KODU	SSIP-13231	DOK.NO	DRW01	16.02.2022
CİHAZ İSMİ	AHU-B52	RV NO		6.11.2023
TOLERANSLAR	DOĞRUSAL: ±1mm AÇISAL:±15'	ÇİZEN	simge.akar	6.11.2023
AKSİ BELİRTİLMEDİĞİ SÜRECE:BOYUTLAR MİLİMETREDİR	ONAY	simge.akar		6.11.2023



ATC Air Trade Centre  
Havalandırma Sistemleri  
San. ve Tic. A.Ş.  
Organize Sanayi Bölgesi 14. Cad. No:15  
35875. Pancar / Torbalı / İzmir Türkiye  
Tel : 0(232) 853 72 84  
Fax : 0(232) 853 72 85  
www.airtradecentre.com